

Article number: 20146B30402SW

Description: E+G
Flanged Connector GN 146-B30-40-2-SW

Measures

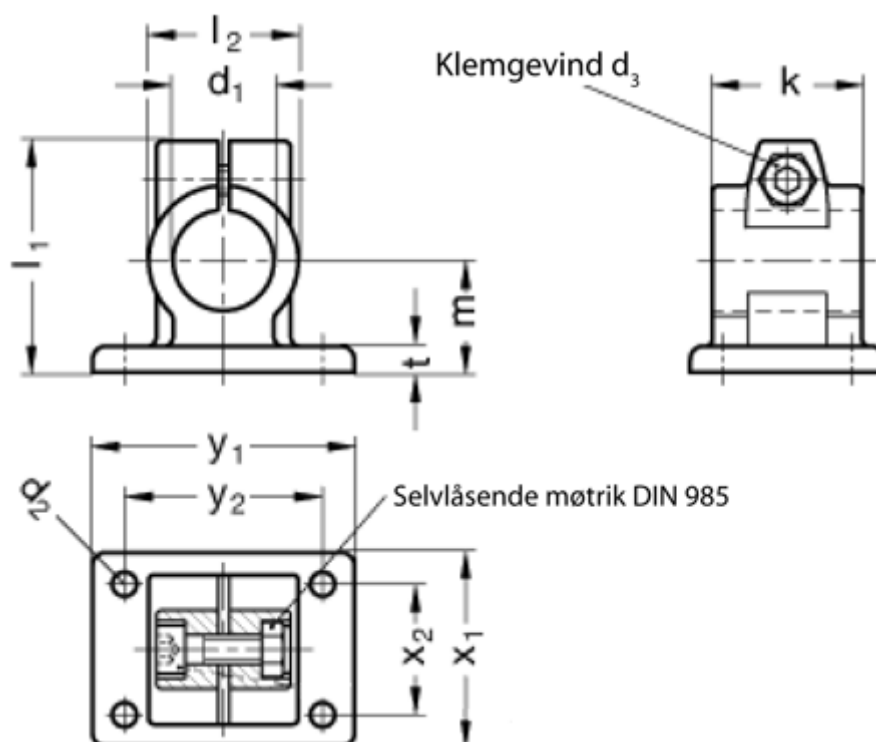

Adjustable clamp lever = GN 911-M 8-32 have to be ordred separately

d1 = B30
d2 = 6.5
d3 = M 8
k = 40
l1 = 62
l2 = 40
m = 30

t = 7
x1 = 52
x2 = 35
y1 = 70
y2 = 53